

Power-Over-Ethernet Module

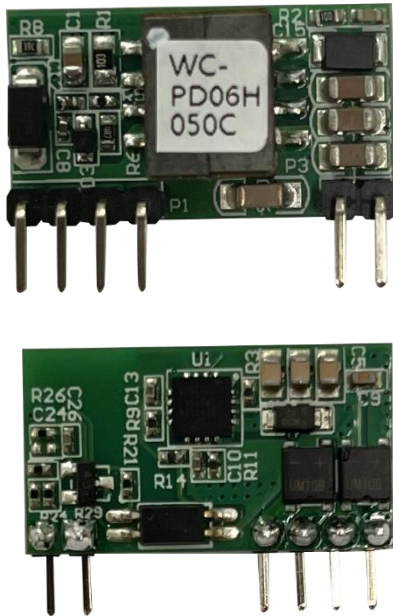

Product characteristics

- Compliance with IEEE802.3af standard.
- 39V~57V wide operating voltage range.
- Maximum output power up to 6W; Rated output: 5V/1.2A.
- The output ripple is less than 150 mV.
- Conversion efficiency can be as high as 88% (input: 48 output)5V@1.2A).
- With over current short circuit under voltage surge and other excellent reliability and circuit protection.
- PCBA standard size: 25.5mm*14mm*12mm
- Input/Output: isolate 1500Vdc.
- High reliability: The design meets the 5 million hour average failure interval.

2.Scope of application

- Video and VoIP Phone
- RFID Reader
- Multiband Access Point
- Surveillance camera

3.describe

- The module is designed to extract power from conventional Class 5 Ethernet cable twisted pairs and meets the IEEE 802.3af Power-Ethernet (PoE) the same time, the module allows the power supply category to select "Intermediate Overlap" and "End Overlap" power supply without distinguishing polarity.
- Based on the IEEE 802.3af standard, this paper establishes information connection about the connection status, device type, power consumption level of the receiving device PD, and then applies power supply to port compatible devices based on PSE to power the PD through ethernet.
- This module DC/DC converter works in a wide input voltage range and low ripple low noise output. The DC/DC converter also has built-in output overload, output short circuit and overtemperature protection, and provides a 1500Vdc (input/output) electrical isolation.

4. Mechanical dimensions

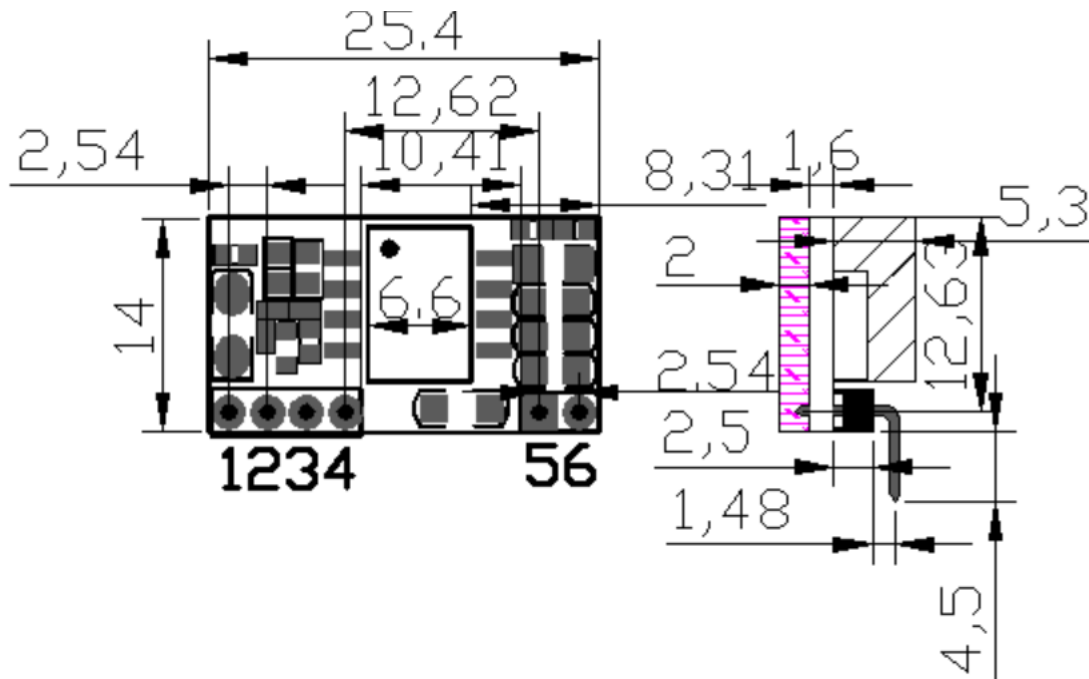

Company (mm)

All the above dimensional errors: (± 0.3)

5. pin definition

| Pin | Name | describe |
|-----|-------|--|
| 1 | VA1 | This input pin is used in conjunction with VA1 and connects to the centre tap of the transformer connected to pins 1& 2 of the RJ45 connector (RX) - it is not polarity sensitive. |
| 2 | VA2 | This input pin is used in conjunction with VA2 and connects to the centre tap of the transformer connected to pins 3& 6 of the RJ45 connector (TX) - it is not polarity sensitive. |
| 3 | VB1 | This input pin is used in conjunction with VB1 and connects to pin 4 & 5 of the RJ45 connector - it is not polarity sensitive. |
| 4 | VB2 | This input pin is used in conjunction with VB2 and connects to pin 7 & 8 of the RJ45 connector - it is not polarity sensitive. |
| 5 | Vout- | is the negative output of the PD. |
| 6 | Vout+ | is the positive output of the PD. |

6. Electrical characteristics

6.1 Absolute maximum rating parameter

| No | parameter | Symbol | MIN | MAX | Units |
|----|----------------------|--------|------|-----|-------|
| 1 | DC Voltage | VCC | 39 | 58 | V |
| 2 | DC Voltage Surge 1ms | VSURGE | -0.6 | 80 | V |
| 3 | ambient temperature | TS | -40 | 80 | °C |

*Exceeding the above rating may cause permanent damage to the product. Functional operations under these conditions are not recommended.

6.2 Recommended working conditions

| No | parameter | Symbol | MIN | TYP | MAX | Units |
|----|---------------------|--------|-----|-----|-----|-------|
| 1 | input voltage | VIN | 39 | 48 | 58 | V |
| 2 | Low Voltage Lock | VLOCK | - | - | 37 | V |
| 3 | working temperature | TOP | -40 | 25 | 80 | °C |

*Applicable only to WC-PD06H050C maximum operating temperature.

6.3 DC Characteristic

| No | parameter | Symbol | MIN | TYP | MAX | Units | Test Opinions |
|----|-----------------------------|--------|------|------|------|-------|---------------------------|
| 1 | Standard Output Voltage | VDC | 4.75 | 5.1 | 5.2 | V | VIN=48v |
| 2 | Output Current (DC VIN=48V) | PWR | - | 1.1 | 1.2 | A | Wide voltage input 40-57V |
| 3 | Power adjustment rate | VLINE | - | 0.1 | - | % | @50% Load |
| 4 | Load Adjustment Rate | VLOAD | - | 1 | - | % | @VIN=48V |
| 5 | Ripple Output Noise | VRN | - | 150 | 200 | mVp-p | @Maximum Load |
| 6 | Minimum Load | RLOAD | 10 | - | - | mA | |
| 7 | Short circuit duration | TSC | - | - | ∞ | sec | |
| 8 | Efficiency (load 80%) | EFF | 85 | 88 | - | % | |
| 9 | Isolation Voltage (I/O) | VISO | - | - | 1500 | VPK | |
| 10 | temperature coefficient | Tc | - | 0.02 | | % | Per °C |
| 11 | dynamic response | Ts | - | 60 | 100 | ms | Vin=48V Vout=max |

1: Typical number is 25 C, nominal voltage is 48V, for auxiliary design only.

2: Output ripple and noise can be reduced by an external filter, see the application instructions.

3: If operated under the specified minimum load, the module emits audible noise and may cause PSE malfunction.

7. Functional Descriptions

7.1 input

WC-PD06H050C input end with bridge stack ensures input polarity protection, user can choose the connection mode as needed.

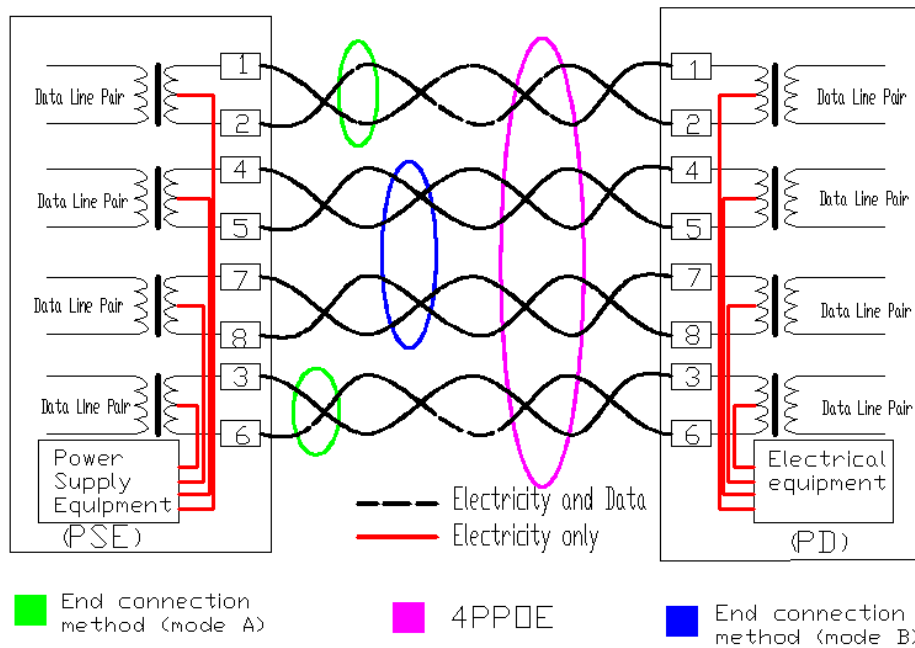

7.2 PD Signature

When the module is connected to the cable, it will automatically provide the Power Device (PD) signature to the PSE when needed. The PSE recognizes that the PD is connected to that line and provides power

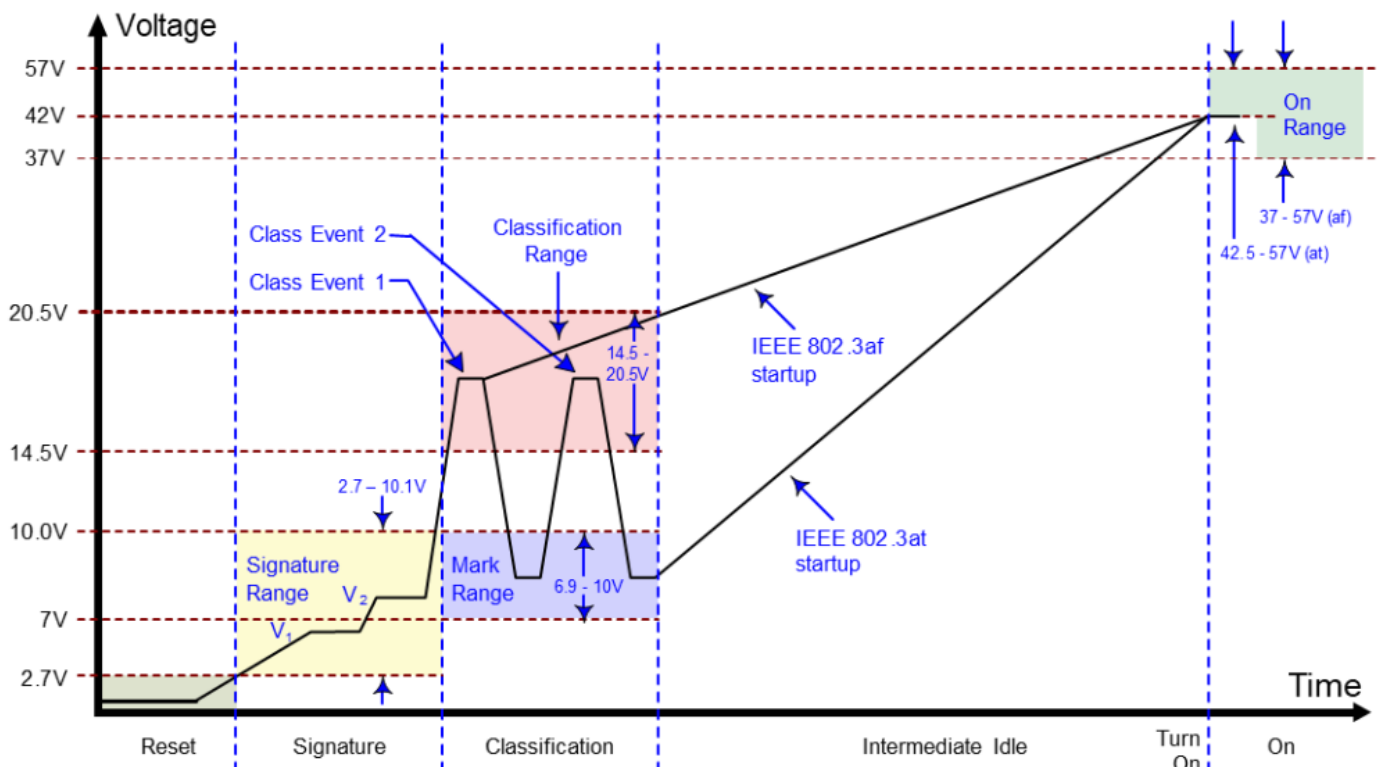

7.3 Power Classification

WC-PD06H050C uses IEEE802.3af standard and runs with Class 3 (6W) power rating by default.

| Define criteria | Cable requirements | Grading parameters | Power Supply Characteristics |
|---------------------------|-----------------------------|--|--|
| IEEE802.3at (PoE Plus) | CAT5 cable or CAT6 cable | Maximum power required for Class4 devices is 13W~25.5W | The DC voltage ranges from 42 to 57V, with a typical value of 48V. Typical operating current is 10~600mA; typical output power: 30W; Class4 rating supported by electrical equipment |
| IEEE802.3af (PoE) | CAT5 cable | Maximum power required for Class0 devices is 0~12.95W | The DC voltage ranges from 40 to 57V, with a typical value of 48V. Typical operating current is 10~350mA; typical output power: 15.4W; The overload detection current is 350~500mA. Provide 4 Class Power Requests for PD Devices ranging from 3.84 to 12.95W |
| | | The maximum power required for Class1 devices is 0~3.84W | |
| | | The maximum power required for Class2 devices is 3.85W~6.49W | |
| | | The maximum power required for Class3 devices is 6.5W~12.95W | |

7.5 Typical schematic diagram

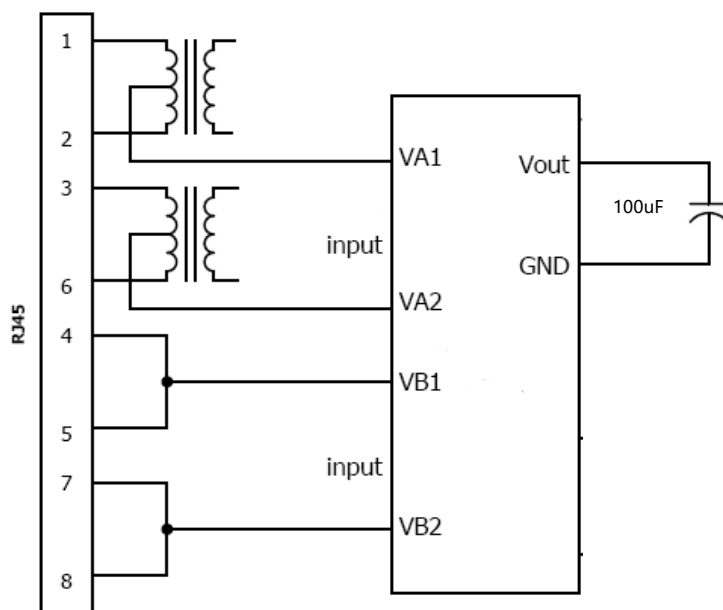

8. PoE Product naming rules

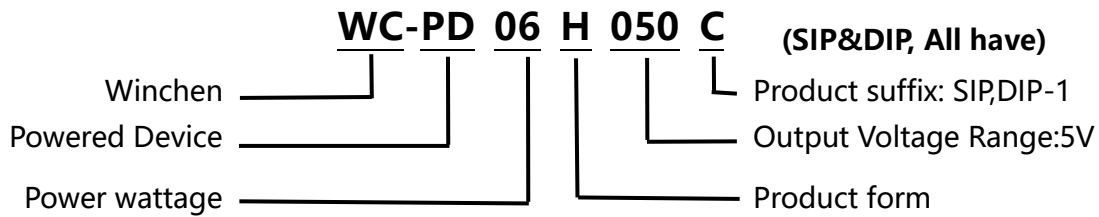

9. Typical applications

This module is used in PSE network cable to convert electric energy to DC-DC to the required voltage of equipment without affecting data signal transmission. It conforms to IEEE 802.3af standard and is used by all equipment terminals

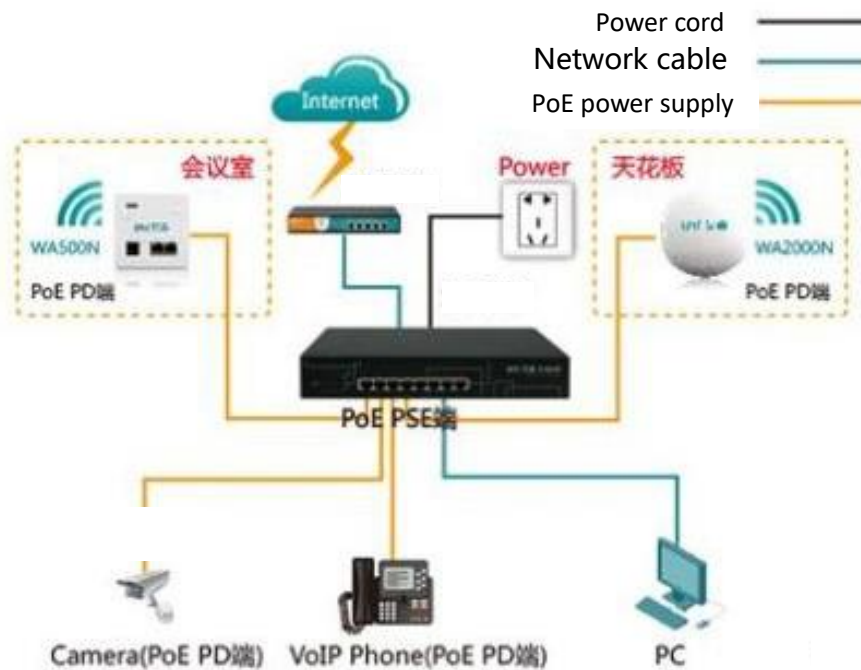

10. Test waveform diagram

Typical features: Vout=5

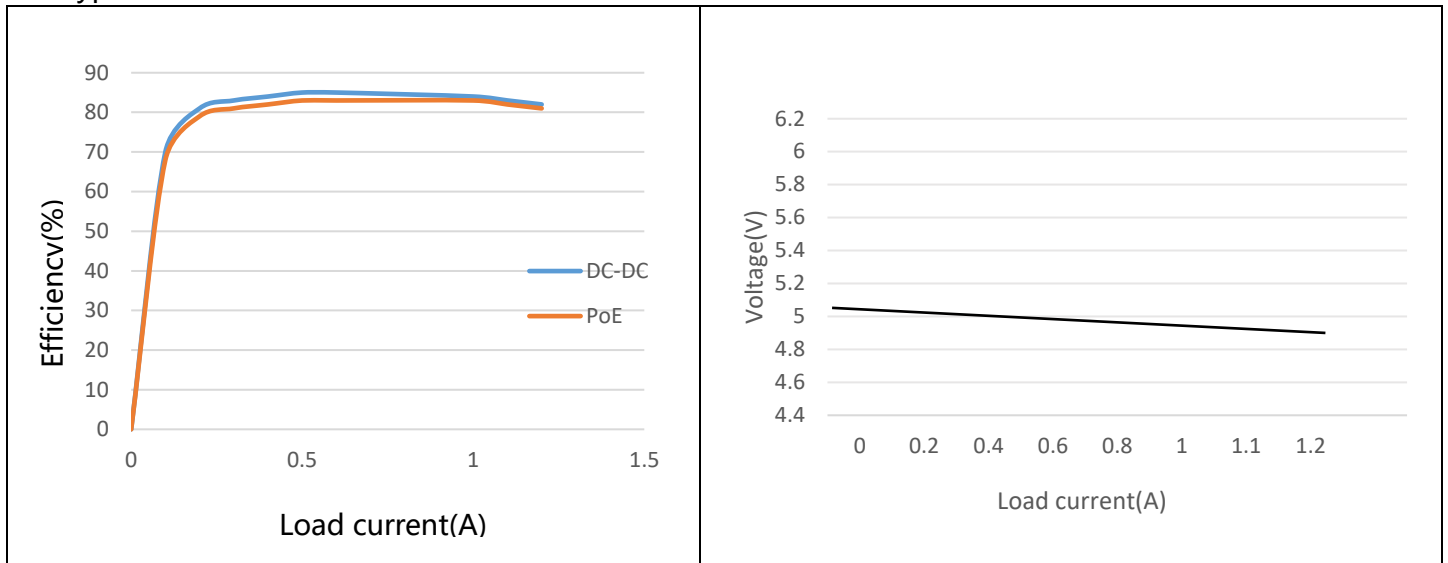

Efficiency (Vout = 5 V)

Output voltage (input 48V)

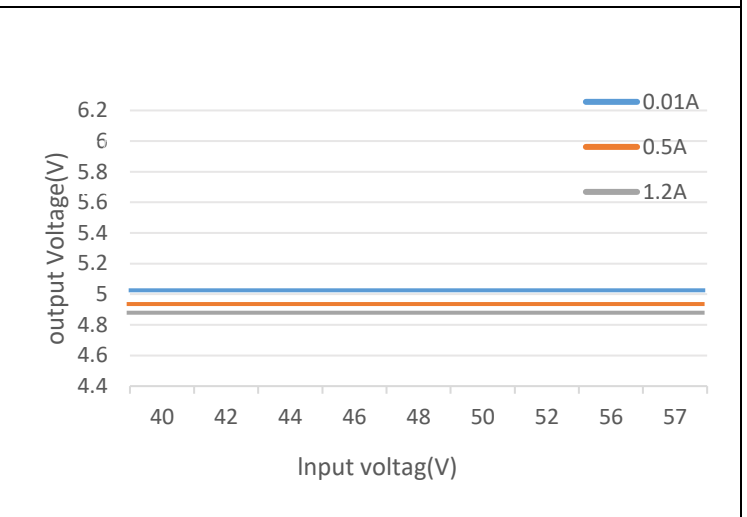
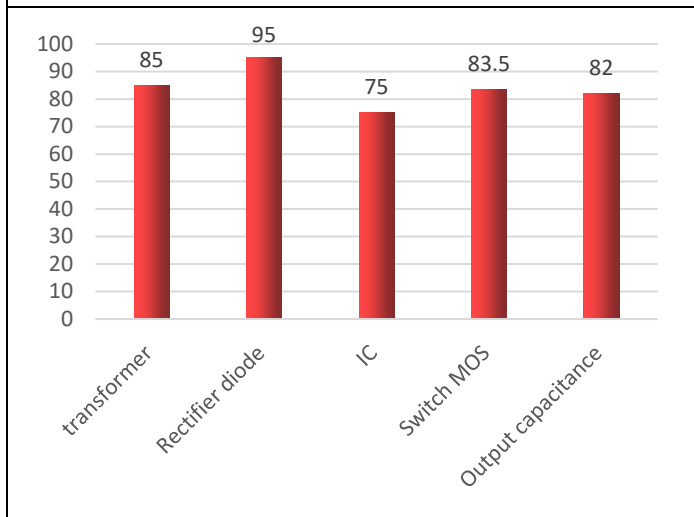

Maximum temperature of components
 Conditions (ambient temperature: 27 °C;
 output power: 5V / 1.2A; frequency: 3H)

Input voltage & output voltage

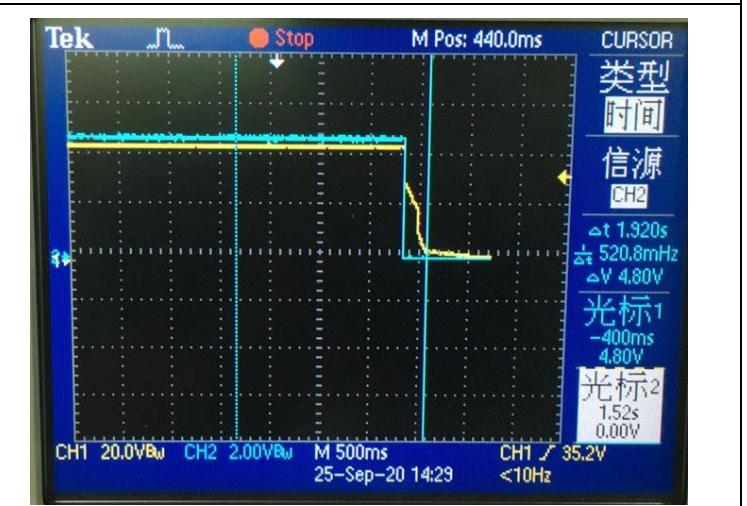
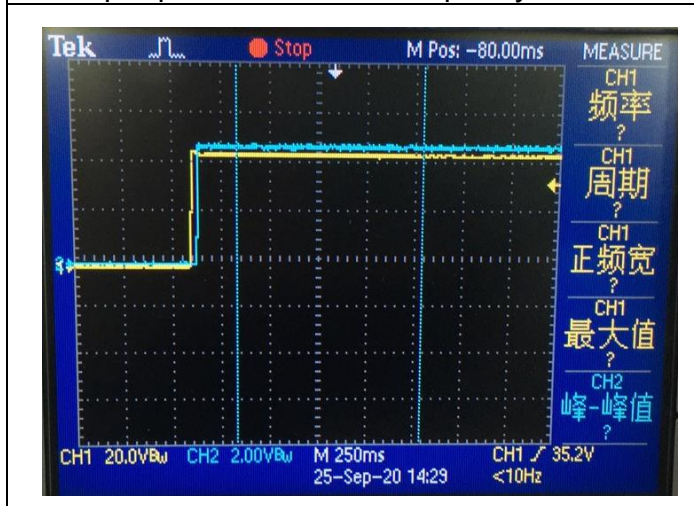

Power on

Power down

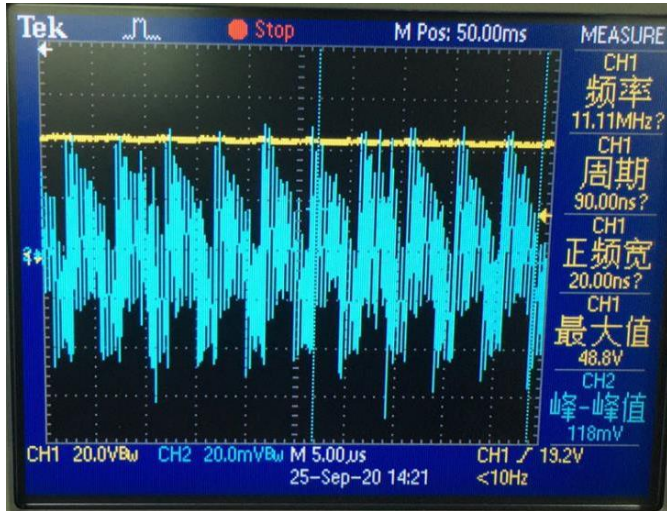

Noise (VIN = 48V, IO = 1.2A, 5 ~ 20MHz bandwidth)



PoEwitching waveform



Power on agreement

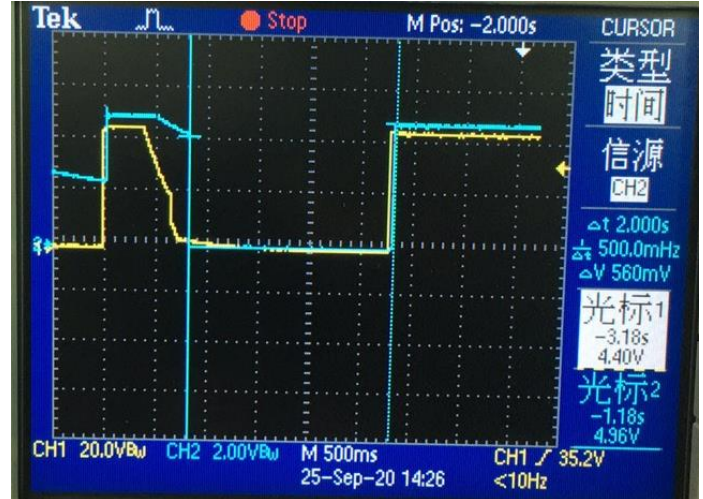

Output response & load (5V / 1.2A)

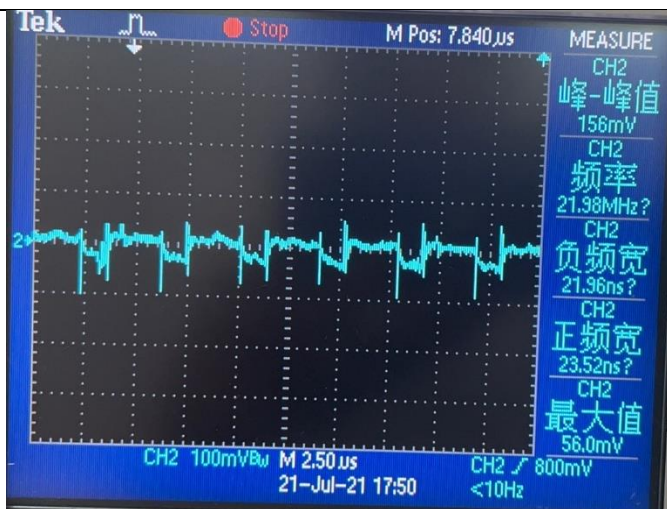

Noise (VIN = 48V, IO = 1.2A, 5 ~ 20MHz bandwidth)



Output response & load (5V / 1.2A)

*Output parallel 10µF / 100nF capacitor is beneficial to suppress ripple